

Panel Frames for Hengstler Modular System 400

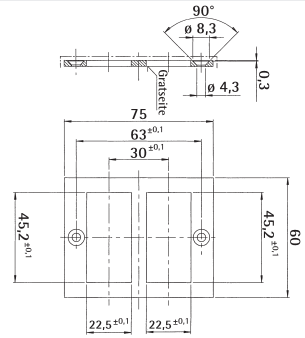

2 counters
24 x 48 mm
in
front panel size 2

Order-Nr. 1 405 696



1 counter 24 x 48 mm
1 counter 48 x 48 mm
in
front panel size 3

Order-Nr. 1 405 693

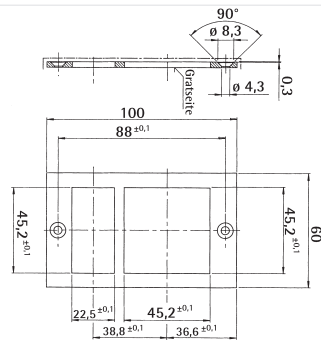

DIMENSIONED DRAWING SIZE 1
Dummy cap with attachment socket

DIMENSIONED DRAWING SIZE 2
Dummy cap with attachment socket

ORDER INFORMATION

Dummy Caps



■ For filling a prepared counter cutout

Front view

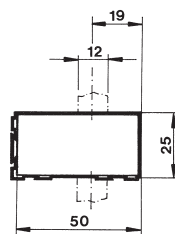

Side view

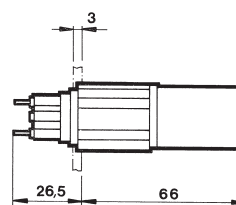

Installation cutout

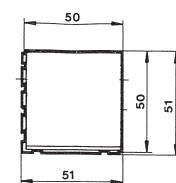
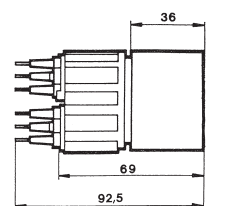
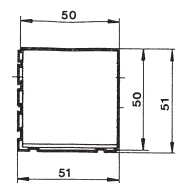
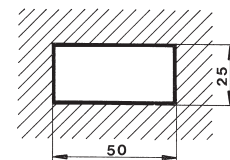

Dimensions in mm

Dummy cap size 1	Ordering code 2 651 009
Dummy cap size 2	Ordering code 1 651 018