

Type 110/110 Type 205, 312



TECHNICAL DATA

Revolution Counter, Length Counter, Stroke counter, with key reset

- 7-digit display
- Large 8 mm digits
- With key reset
- Protection class IP 30

Display	7-digit (999999.9 m/dm)
Digit height	8 mm
Protection class (DIN 4050)	IP 30
Case	die-cast zinc, black
Cover	plastic (ASB), grey
Weight	approx. 430 g
Counting mode	+ (-) adding in specified direction, subtracting in reverse
Transmission ratio	1:2, 1:5 or 1:10, depending on version
Max. speed	3000 digits/min
Torque	0.5 Ncm
Reset	manual reset with removable key on either side
⚠	Don't push the reset pushbutton during the process

DIMENSIONS

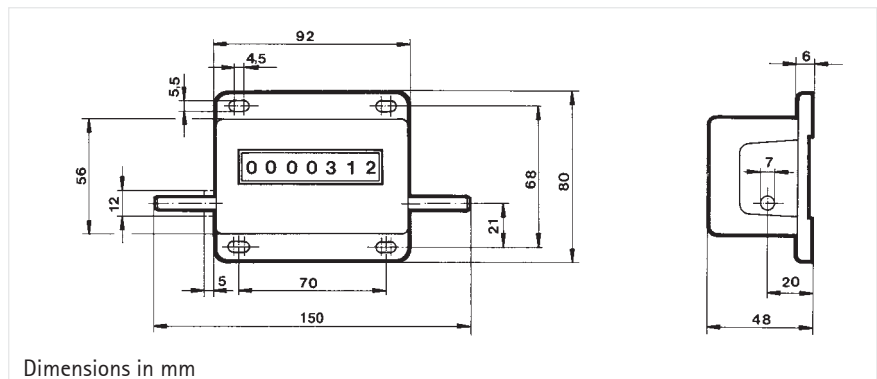

ORDER INFORMATION

Revolution Counter 110/111

Length Counter 205

Stroke Counter 312

Actuation	Sense of rotation	Transm. ratio 1:1	Transm. ratio 1:2	Transm. ratio 1:5	Transm. ratio 1:10
☐	Bz/Bw	0 110 001			
☐	Bz	0 111 001			
☐	Bw	0 111 002			
☐	Bz		0 205 003	0 205 001	0 205 005
☐	Bw			0 205 002	0 205 006
☐	Bz	0 312 001			
☐	Bw	0 312 002			

* on request

For measuring wheels and stroke lever see accessories.

Replacement key 2 312 002