

GXL SERIES

Micro-size Inductive Proximity Sensor **Amplifier Built-in**

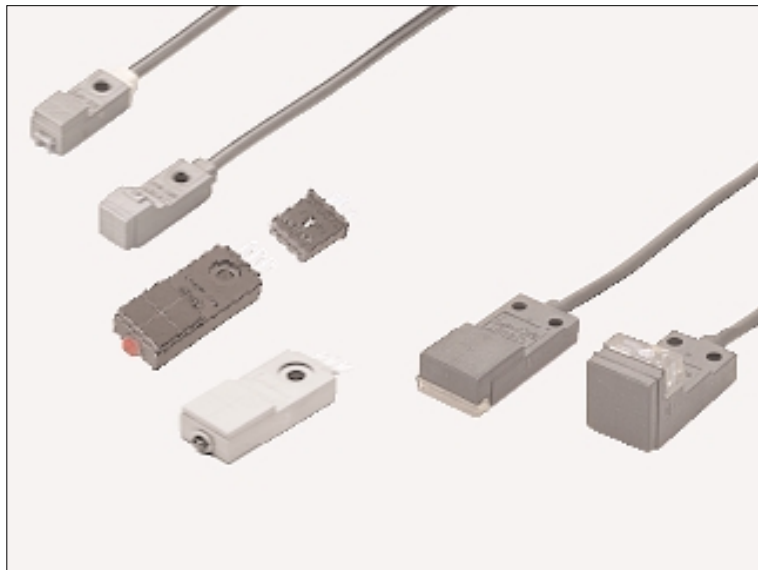

High performance
in micro-size design

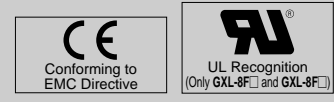

Wide model variety

Models ranging from extremely compact type to long sensing range type are available to suit various applications.

Versatile mounting

Since the sensor is fingertip size, it can be mounted in a tight space.



Reduced wiring operation

The wiring cost of the DC 2-wire type is 2/3 that of a conventional model. Besides, the possibility of miswiring is reduced.

Particularly convenient when many sensors are used.

Wiring of the 3-wire type is cumbersome.

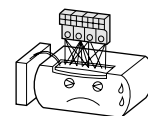

Wiring of the 2-wire type is simple and neat.

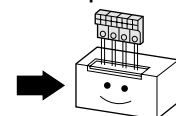

Flexible cable type

The bending durability of its cable is ten times that of the conventional model. The sensor can be mounted on a moving table or a robot arm.

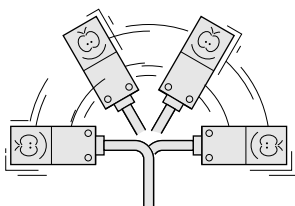

※ Except PNP output type and 5 m 16.404 ft cable attached NPN output type

APPLICATIONS

Detecting wafer frame

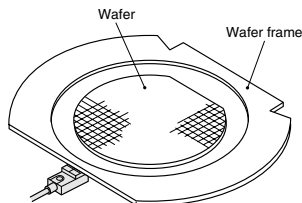

Detecting aluminum pallet

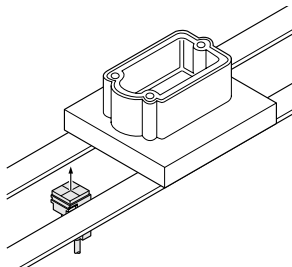

Code reading

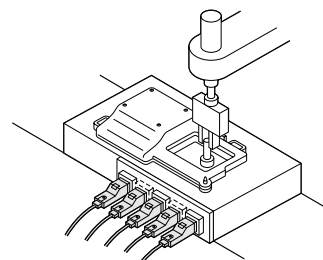

ORDER GUIDE

GXL-8 type

Type	Appearance (mm in)	Sensing range (Note 1)	Model No. (Note 2)	Output	Output operation
DC 2-wire	Front sensing 	Maximum operation distance 2.5 mm 0.098 in Stable sensing range (0 to 1.8 mm) (0 to 0.071 in)	GXL-8FU	Non-contact DC 2-wire type	Normally open
			GXL-8FUI		Normally closed
	GXL-8FUIB		Normally open		
	GXL-8HU		Normally closed		
	GXL-8HUI		Normally open		
	GXL-8HUB		Normally closed		
NPN output	Front sensing 	Maximum operation distance 2.5 mm 0.098 in Stable sensing range (0 to 1.8 mm) (0 to 0.071 in)	GXL-8F	NPN open-collector transistor	Normally open
			GXL-8FI		Normally closed
	GXL-8FIB		Normally open		
	GXL-8H		Normally open		
	GXL-8HI		Normally open		
	GXL-8HB		Normally closed		
Top sensing 	Maximum operation distance 2.5 mm 0.098 in Stable sensing range (0 to 1.8 mm) (0 to 0.071 in)	Maximum operation distance 2.5 mm 0.098 in Stable sensing range (0 to 1.8 mm) (0 to 0.071 in)	GXL-8FU	Non-contact DC 2-wire type	Normally open
			GXL-8FUI		Normally closed
GXL-8FUIB			Normally open		
GXL-8HU			Normally closed		
GXL-8HUI			Normally open		
GXL-8HUB			Normally closed		
Top sensing 	Maximum operation distance 2.5 mm 0.098 in Stable sensing range (0 to 1.8 mm) (0 to 0.071 in)	Maximum operation distance 2.5 mm 0.098 in Stable sensing range (0 to 1.8 mm) (0 to 0.071 in)	GXL-8F	NPN open-collector transistor	Normally open
			GXL-8FI		Normally closed
GXL-8FIB			Normally open		
GXL-8H			Normally open		
GXL-8HI			Normally open		
GXL-8HB			Normally closed		

Notes: 1) The maximum operation distance stands for the maximum distance for which the sensor can detect the standard sensing object. The stable sensing range stands for the sensing range for which the sensor can stably detect the standard sensing object even if there is an ambient temperature drift and/or supply voltage fluctuation.
 2) 'I' in the model No. indicates a different frequency type.

GXL-N12 type

Type	Appearance (mm in)	Sensing range (Note 1)	Model No. (Note 2)	Output	Output operation
NPN output	Cable type 	Maximum operation distance 3 mm 0.118 in Stable sensing range (0 to 2 mm) (0 to 0.079 in)	GXL-N12F (Note 3)	NPN open-collector transistor	Normally open
			GXL-N12FI (Note 3)		Normally closed
	GXL-N12FB		Normally open		
	GXL-N12FT (Note 3)		Normally closed		
	GXL-N12FTI (Note 3)		Normally open		
	GXL-N12FTB		Normally closed		
PNP output	Cable type 	Maximum operation distance 3 mm 0.118 in Stable sensing range (0 to 2 mm) (0 to 0.079 in)	GXL-N12F-P	PNP open-collector transistor	Normally open
			GXL-N12FI-P		Normally closed
	GXL-N12FB-P		Normally open		
	GXL-N12FT-P		Normally closed		
	GXL-N12FTI-P		Normally open		
	GXL-N12FTB-P		Normally closed		
Terminal type 	Maximum operation distance 3 mm 0.118 in Stable sensing range (0 to 2 mm) (0 to 0.079 in)	Maximum operation distance 3 mm 0.118 in Stable sensing range (0 to 2 mm) (0 to 0.079 in)	GXL-N12F (Note 3)	NPN open-collector transistor	Normally open
			GXL-N12FI (Note 3)		Normally closed
GXL-N12FB			Normally open		
GXL-N12FT (Note 3)			Normally closed		
GXL-N12FTI (Note 3)			Normally open		
GXL-N12FTB			Normally closed		
Terminal type 	Maximum operation distance 3 mm 0.118 in Stable sensing range (0 to 2 mm) (0 to 0.079 in)	Maximum operation distance 3 mm 0.118 in Stable sensing range (0 to 2 mm) (0 to 0.079 in)	GXL-N12F-P	PNP open-collector transistor	Normally open
			GXL-N12FI-P		Normally closed
GXL-N12FB-P			Normally open		
GXL-N12FT-P			Normally closed		
GXL-N12FTI-P			Normally open		
GXL-N12FTB-P			Normally closed		

Notes: 1) The maximum operation distance stands for the maximum distance for which the sensor can detect the standard sensing object. The stable sensing range stands for the sensing range for which the sensor can stably detect the standard sensing object even if there is an ambient temperature drift and/or supply voltage fluctuation.
 2) 'I' in the model No. indicates a different frequency type.
 3) These models, with normally open NPN output, are also available as 5 V supply voltage type. Please contact our office for details.

ORDER GUIDE

GXL-15 (Standard) type

Type	Appearance (mm in)	Sensing range (Note 1)	Model No. (Note 2)	Output	Output operation	
DC 2-wire	Front sensing 		GXL-15FU	Non-contact DC 2-wire type	Normally open	
	Top sensing 		GXL-15FUI		Normally closed	
	NPN output		Front sensing 		GXL-15FUB	NPN open-collector transistor
Top sensing 			GXL-15HUI		Normally open	
Front sensing 			GXL-15HUB		Normally closed	
Top sensing 	GXL-15HUIB		Normally open			
PNP output	Front sensing 		GXL-15F	PNP open-collector transistor	Normally open	
			GXL-15FI		Normally closed	
			GXL-15FB		Normally open	
			GXL-15FIB		Normally closed	
			GXL-15H		Normally open	
			GXL-15HI		Normally closed	
PNP output	Front sensing 	GXL-15HB	PNP open-collector transistor	Normally open		
		GXL-15HIB		Normally closed		
		GXL-15F-P		Normally open		
PNP output	Front sensing 	GXL-15FI-P	PNP open-collector transistor	Normally open		
		GXL-15FB-P		Normally closed		
		GXL-15FIB-P		Normally closed		

Notes: 1) The maximum operation distance stands for the maximum distance for which the sensor can detect the standard sensing object. The stable sensing range stands for the sensing range for which the sensor can stably detect the standard sensing object even if there is an ambient temperature drift and/or supply voltage fluctuation.
2) 'I' in the model No. indicates a different frequency type.

GXL-15 (Long sensing range) type ... For mounting on non-magnetic material (Note 3)

Type	Appearance (mm in)	Sensing range (Note 1)	Model No. (Note 2)	Output	Output operation	
DC 2-wire	Front sensing 		GXL-15FLU	Non-contact DC 2-wire type	Normally open	
	Top sensing 		GXL-15FLUI		Normally closed	
	NPN output		Front sensing 		GXL-15FLUB	NPN open-collector transistor
Top sensing 			GXL-15HLUI		Normally open	
Front sensing 			GXL-15HLUB		Normally closed	
Top sensing 	GXL-15HLUIB		Normally open			
NPN output	Front sensing 		GXL-15HL	NPN open-collector transistor	Normally open	
			GXL-15HLI		Normally closed	
			GXL-15HLB		Normally open	
NPN output	Front sensing 		GXL-15HLIB	NPN open-collector transistor	Normally closed	

Notes: 1) The maximum operation distance stands for the maximum distance for which the sensor can detect the standard sensing object. The stable sensing range stands for the sensing range for which the sensor can stably detect the standard sensing object even if there is an ambient temperature drift and/or supply voltage fluctuation.
2) 'I' in the model No. indicates a different frequency type.
3) To mount the long sensing range **GXL-15** on a magnetic body, such as iron, the enclosed aluminum sheet, or any other aluminum sheet having a minimum size of 30 × 39.5 × t 0.3 mm 1.181 × 1.555 × t 0.012 in (**GXL-15HLU** □ / **GXL-15HL** □: 30 × 30 × t 0.3 mm 1.181 × 1.181 × t 0.012 in), should be inserted between the sensor and the magnetic body. However, it is not necessary to use the aluminum sheet when mounting on a non-magnetic body, such as aluminum or an insulator.

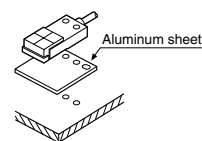

ORDER GUIDE

Flexible cable type and 5 m 16.404 ft cable length type

Flexible cable type and 5 m 16.404 ft cable length type (standard: 1 m 3.281 ft) are also available.

• Table of Model Nos.

Type	Standard	Flexible cable type	5 m 16.404 ft cable length type	Flexible cable & 5 m 16.404 ft cable length type	
DC 2-wire	Front sensing	GXL-8FU	GXL-8FU-R	GXL-8FU-C5	GXL-8FU-R-C5
		GXL-8FUI	GXL-8FUI-R	GXL-8FUI-C5	GXL-8FUI-R-C5
		GXL-8FUB	GXL-8FUB-R	GXL-8FUB-C5	GXL-8FUB-R-C5
		GXL-8FUIB	GXL-8FUIB-R	GXL-8FUIB-C5	GXL-8FUIB-R-C5
		GXL-8HU	GXL-8HU-R	GXL-8HU-C5	GXL-8HU-R-C5
		GXL-8HUI	GXL-8HUI-R	GXL-8HUI-C5	GXL-8HUI-R-C5
	Top sensing	GXL-8HUB	GXL-8HUB-R	GXL-8HUB-C5	GXL-8HUB-R-C5
		GXL-8HUIB	GXL-8HUIB-R	GXL-8HUIB-C5	GXL-8HUIB-R-C5
		GXL-15FU	GXL-15FU-R	GXL-15FU-C5	GXL-15FU-R-C5
		GXL-15FUI	GXL-15FUI-R	GXL-15FUI-C5	GXL-15FUI-R-C5
		GXL-15FUB	GXL-15FUB-R	GXL-15FUB-C5	GXL-15FUB-R-C5
		GXL-15FUIB	GXL-15FUIB-R	GXL-15FUIB-C5	GXL-15FUIB-R-C5
	Front sensing	GXL-15HU	GXL-15HU-R	GXL-15HU-C5	GXL-15HU-R-C5
		GXL-15HUI	GXL-15HUI-R	GXL-15HUI-C5	GXL-15HUI-R-C5
		GXL-15HUB	GXL-15HUB-R	GXL-15HUB-C5	GXL-15HUB-R-C5
		GXL-15HUIB	GXL-15HUIB-R	GXL-15HUIB-C5	GXL-15HUIB-R-C5
		GXL-15FLU	GXL-15FLU-R	GXL-15FLU-C5	GXL-15FLU-R-C5
		GXL-15FLUI	GXL-15FLUI-R	GXL-15FLUI-C5	GXL-15FLUI-R-C5
	Top sensing	GXL-15FLUB	GXL-15FLUB-R	GXL-15FLUB-C5	GXL-15FLUB-R-C5
		GXL-15FLUIB	GXL-15FLUIB-R	GXL-15FLUIB-C5	GXL-15FLUIB-R-C5
		GXL-15HLU	GXL-15HLU-R	GXL-15HLU-C5	GXL-15HLU-R-C5
		GXL-15HLUI	GXL-15HLUI-R	GXL-15HLUI-C5	GXL-15HLUI-R-C5
		GXL-15HLUB	GXL-15HLUB-R	GXL-15HLUB-C5	GXL-15HLUB-R-C5
		GXL-15HLUIB	GXL-15HLUIB-R	GXL-15HLUIB-C5	GXL-15HLUIB-R-C5
NPN output	Front sensing	GXL-8F	GXL-8F-R	GXL-8F-C5	GXL-8F-R-C5
		GXL-8FI	GXL-8FI-R	GXL-8FI-C5	GXL-8FI-R-C5
		GXL-8FB	GXL-8FB-R	GXL-8FB-C5	GXL-8FB-R-C5
		GXL-8FIB	GXL-8FIB-R	GXL-8FIB-C5	GXL-8FIB-R-C5
		GXL-8H	GXL-8H-R	GXL-8H-C5	
		GXL-8HI	GXL-8HI-R	GXL-8HI-C5	
	Top sensing	GXL-8HB	GXL-8HB-R	GXL-8HB-C5	
		GXL-8HIB	GXL-8HIB-R	GXL-8HIB-C5	
		GXL-N12F	GXL-N12F-R	GXL-N12F-C5	GXL-N12F-R-C5
		GXL-N12FI	GXL-N12FI-R	GXL-N12FI-C5	GXL-N12FI-R-C5
		GXL-N12FB	GXL-N12FB-R	GXL-N12FB-C5	GXL-N12FB-R-C5
		GXL-N12FIB	GXL-N12FIB-R	GXL-N12FIB-C5	GXL-N12FIB-R-C5
	Front sensing	GXL-N12FT			
		GXL-N12FTI			
		GXL-N12FTB			
		GXL-N12FTIB			
		GXL-15F	GXL-15F-R	GXL-15F-C5	GXL-15F-R-C5
		GXL-15FI	GXL-15FI-R	GXL-15FI-C5	GXL-15FI-R-C5
	Top sensing	GXL-15FB	GXL-15FB-R	GXL-15FB-C5	GXL-15FB-R-C5
		GXL-15FIB	GXL-15FIB-R	GXL-15FIB-C5	
		GXL-15H		GXL-15H-C5	
		GXL-15HI			
		GXL-15HB		GXL-15HB-C5	
		GXL-15HIB			
Top sensing	GXL-15HL		GXL-15HL-C5		
	GXL-15HLI				
	GXL-15HLB				
	GXL-15HLIB				
	GXL-N12F-P		GXL-N12F-P-C5		
	GXL-N12FI-P		GXL-N12FI-P-C5		
Front sensing	GXL-N12FB-P		GXL-N12FB-P-C5		
	GXL-N12FIB-P		GXL-N12FIB-P-C5		
	GXL-N12FT-P				
	GXL-N12FTI-P				
	GXL-N12FTB-P				
	GXL-N12FTIB-P				
Front sensing	GXL-15F-P		GXL-15F-P-C5		
	GXL-15FI-P		GXL-15FI-P-C5		
	GXL-15FB-P		GXL-15FB-P-C5		
	GXL-15FIB-P		GXL-15FIB-P-C5		

Amplifier Built-in

Amplifier-separated

GXL

GL-6

GL-8/8U

GL-N12

GL-18H/18HL

GX-U/FU

GX-N

GX

GA-10/GH

GXL

ORDER GUIDE

Accessories

- **MS-GXL8**
(Sensor mounting bracket for GXL-8F, GXL-8H type)

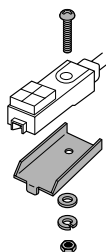

1 pc. each of screw, nut, spring washer and plain washer is attached.

- **MS-GXL8-4**
(Sensor mounting bracket for GXL-8FU, GXL-8HU type)
- **MS-GXL12-1**
(Sensor mounting bracket for GXL-N12 type)

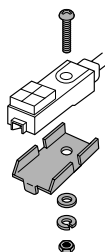

1 pc. each of screw, nut, spring washer and plain washer is attached.

Not included with the **MS-GXL12-1**.
(Bracket only)
Please use only the items included with the sensor.

- **MS-A15F**
(Aluminum sheet for GXL-15FLU type)
- **MS-A15H**
(Aluminum sheet for GXL-15HLU, GXL-15HL type)

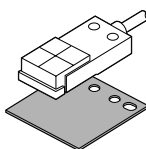

OPTIONS

Designation	Model No.	Description
Connector	CN-13	Connector for the terminal type
	CN-13-C1	Length: 1 m 3.281 ft Mating cable for the terminal type
	CN-13-C3	Length: 3 m 9.843 ft Mating cable for the terminal type
Sensor mounting bracket	MS-GXL8-3	Mounting bracket for NPN output of GXL-8 type
	MS-GXL12-2	Mounting bracket for GXL-N12 type
	MS-GXL15	Mounting bracket for GXL-15 type
	MS-GXL15-2	Mounting bracket for GXL-15F type

Connector

- **CN-13**
- **CN-13-C1**
- **CN-13-C3**

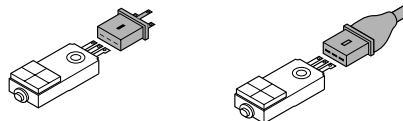

Sensor mounting bracket

- **MS-GXL8-3**
- **MS-GXL12-2**

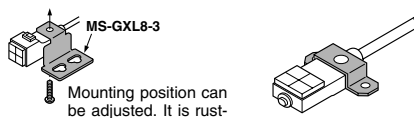

Mounting position can be adjusted. It is rust-free, being stainless steel.

Screws are not supplied.

A set of one M2.6 (length: 8 mm 0.315 in) pan head screw and two M3 (length: 8 mm 0.315 in) screws with washers are attached.

- **MS-GXL15**
- **MS-GXL15-2**



Screws are not supplied.

SPECIFICATIONS

DC 2-wire type

Item	Standard Model No.	Type		GXL-15 type			
		GXL-8 type		Standard		Long sensing range (For mounting on non-magnetic body) (Note 1)	
		Front sensing	Top sensing	Front sensing	Top sensing	Front sensing	Top sensing
		GXL-8FU	GXL-8HU	GXL-15FU	GXL-15HU	GXL-15FLU	GXL-15HLU
Max. operation distance (Note 2)		2.5 mm 0.098 in ± 20 %		5 mm 0.197 in ± 10 %		8 mm 0.315 in ± 10 %	
Stable sensing range (Note 2)		0 to 1.8 mm 0 to 0.071 in		0 to 4 mm 0 to 0.157 in		0 to 6.4 mm 0 to 0.252 in	
Standard sensing object		Iron sheet 15 × 15 × t 1 mm 0.591 × 0.591 × t 0.039 in		Iron sheet 20 × 20 × t 1 mm 0.787 × 0.787 × t 0.039 in		Iron sheet 30 × 30 × t 1 mm 1.181 × 1.181 × t 0.039 in	
Hysteresis		20 % or less of operation distance					
Repeatability		Along sensing axis, perpendicular to sensing axis: 0.04 mm 0.002 in or less					
Supply voltage		12 to 24 V DC ± 10 % Ripple P-P 10 % or less					
Current consumption (Note 3)		0.8 mA or less					
Output		Non-contact DC 2-wire type • Load current: 3 to 70 mA (Note 4) • Residual voltage: 3 V or less (Note 5)		Non-contact DC 2-wire type • Load current: 3 to 100 mA (Note 4) • Residual voltage: 3 V or less (Note 5)			
	Utilization category	DC-12 or DC-13					
	Short-circuit protection	Incorporated					
Max. response frequency		1 kHz					
Operation indicator		Normally closed type: Red LED (lights up when the output is ON)					
2-color indicator		Normally open type: Lights up in green under stable sensing condition Lights up in red under unstable sensing condition					
Environmental resistance	Pollution degree	3 (Industrial environment)					
	Protection	IP67 (IEC), IP67 g (JEM)					
	Ambient temperature	− 25 to + 70 °C − 13 to + 158 °F, Storage: − 30 to + 80 °C − 22 to + 176 °F					
	Ambient humidity	45 to 85 % RH, Storage: 35 to 95 % RH					
	EMC	EN 50081-2, EN 50082-2, EN 60947-5-2					
	Voltage withstandability	1,000 V AC for one min. between all supply terminals connected together and enclosure					
	Insulation resistance	50 MΩ, or more, with 250 V DC megger between all supply terminals connected together and enclosure					
	Vibration resistance	10 to 55 Hz frequency, 1.5 mm 0.059 in amplitude in X, Y and Z directions for two hours each					
Shock resistance	1,000 m/s ² acceleration (100 G approx.) in X, Y and Z directions for three times each						
Sensing range variation	Temperature characteristics	Over ambient temperature range − 25 to + 70 °C − 13 to + 158 °F: Within $\pm \frac{15}{10}$ % of sensing range at + 20 °C + 68 °F					
	Voltage characteristics	Within ± 2 % for ± 10 % fluctuation of the supply voltage					
Material		Enclosure: PBT, Indicator part: Polyallylate			Enclosure: PET (Glass fiber reinforced) Indicator part: Polyallylate	Enclosure: PBT Indicator part: Polyallylate	Enclosure: PET (Glass fiber reinforced) Indicator part: Polyallylate
Cable (Note 6)		0.15 mm ² 2-core oil, heat and cold resistant cable, 1 m 3.281 ft long		0.2 mm ² 2-core oil, heat and cold resistant cable, 1 m 3.281 ft long			
Cable extension		Extension up to total 50 m 164.042 ft is possible with 0.3 mm ² , or more, cable.					
Weight		12 g approx.		20 g approx.			
Accessories		MS-GXL8-4 (Sensor mounting bracket): 1 set		—		MS-A15F (Aluminum sheet): 1 pc.	MS-A15H (Aluminum sheet): 1 pc.

- Notes: 1) To mount the long sensing range **GXL-15** type on a magnetic body, such as iron, the enclosed aluminum sheet, or any other aluminum sheet having a minimum size of 30 × 39.5 × t 0.3 mm 1.181 × 1.555 × t 0.012 in (**GXL-15HLU** type: 30 × 30 × t 0.3 mm 1.181 × 1.181 × t 0.012 in), should be inserted between the sensor and the magnetic body.
However, it is not necessary to use the aluminum sheet when mounting on a non-magnetic body, such as, aluminum or an insulator.
- 2) The maximum operation distance stands for the maximum distance for which the sensor can detect the standard sensing object.
The stable sensing range stands for the sensing range for which the sensor can stably detect the standard sensing object even if there is an ambient temperature drift and/or supply voltage fluctuation.
- 3) It is the leakage current when the output is in the OFF state.
- 4) The maximum load current varies with the ambient temperature. Refer to 'I/O CIRCUIT AND WIRING DIAGRAMS' (p.691~) for more details.
- 5) When the cable is extended, the residual voltage becomes larger according to the resistance of the cable.
The residual voltage of 5 m 16.404 ft cable length type increases by 0.1 V.
- 6) The flexible cable type (model No. with suffix **-R**) has a 0.15 mm² (**GXL-15** type: 0.2 mm²) flexible, oil, heat and cold resistant cable, 1 m 3.281 ft long.

INDUCTIVE PROXIMITY SENSORS

GXL

GL-6

GL-8/8U

GL-N12

GL-18H/18HL

GX-U/FU

GX-N

GX

Amplifier-separated
GA-10/GH

SPECIFICATIONS

NPN and PNP output type

Type	NPN output						PNP output			
	GXL-8 type		GXL-N12 type		GXL-15 type		GXL-N12 type		GXL-15 type	
			Cable type	Terminal type	Standard		Long sensing range (For mounting on non-magnetic body (Note 1))	Cable type	Terminal type	Standard
Standard Model No.	Front sensing	Top sensing	Front sensing		Front sensing	Top sensing		Top sensing	Front sensing	
Item	GXL-8F	GXL-8H	GXL-N12F	GXL-N12FT	GXL-15F	GXL-15H	GXL-15HL	GXL-N12F-P	GXL-N12FT-P	GXL-15F-P
Max. operation distance (Note 2)	2.5 mm 0.098 in ± 20 %		3 mm 0.118 in ± 10 %		5 mm 0.197 in ± 10 %		8 mm 0.315 in ± 10 %	3 mm 0.118 in ± 10 %		5 mm 0.197 in ± 10 %
Stable sensing range (Note 2)	0 to 1.8 mm 0 to 0.071 in		0 to 2 mm 0 to 0.079 in		0 to 4 mm 0 to 0.157 in		0 to 6.4 mm 0 to 0.252 in	0 to 2 mm 0 to 0.079 in		0 to 4 mm 0 to 0.157 in
Standard sensing object	Iron sheet 15 × 15 × t 1 mm 0.591 × 0.591 × t 0.039 in		Iron sheet 20 × 20 × t 1 mm 0.787 × 0.787 × t 0.039 in		Iron sheet 20 × 20 × t 1 mm 0.787 × 0.787 × t 0.039 in		Iron sheet 30 × 30 × t 1 mm 1.181 × 1.181 × t 0.039 in	Iron sheet 20 × 20 × t 1 mm 0.787 × 0.787 × t 0.039 in		Iron sheet 20 × 20 × t 1 mm 0.787 × 0.787 × t 0.039 in
Hysteresis	20 % or less of operation distance									
Repeatability	Along sensing axis, perpendicular to sensing axis: 0.04 mm 0.002 in or less					Along sensing axis, perpendicular to sensing axis: 0.06 mm 0.002 in or less		Along sensing axis, perpendicular to sensing axis: 0.04 mm 0.002 in or less		
Supply voltage	12 to 24 V DC ± 10 % Ripple P-P 10 % or less									
Current consumption	15 mA or less									
Output	NPN open-collector transistor • Maximum sink current: 100 mA • Applied voltage: 30 V DC or less (between output and 0 V) • Residual voltage: 1 V or less (at 100 mA sink current) 0.4 V or less (at 16 mA sink current)						PNP open-collector transistor • Maximum source current: 100 mA • Applied voltage: 30 V DC or less (between output and + V) • Residual voltage: 1 V or less (at 100 mA source current) 0.4 V or less (at 16 mA source current)			
Utilization category	DC-12 or DC-13									
Short-circuit protection	—									
Max. response frequency	500 Hz				250 Hz			500 Hz		250 Hz
Operation indicator	Red LED (lights up when the output is ON)									
Environmental resistance	Pollution degree	3 (Industrial environment)								
	Protection	IP67 (IEC), IP67 g (JEM) except for the terminal type								
	Ambient temperature	− 10 to + 55 °C 14 to + 131 °F, Storage: − 30 to + 80 °C − 22 to + 176 °F								
	Ambient humidity	45 to 85 % RH, Storage: 35 to 95 % RH								
	EMC	EN 50081-2, EN 50082-2, EN 60947-5-2								
	Voltage withstandability	1,000 V AC for one min. between all supply terminals connected together and enclosure								
	Insulation resistance	50 MΩ, or more, with 250 V DC megger between all supply terminals connected together and enclosure								
Vibration resistance	10 to 55 Hz frequency, 1.5 mm 0.059 in amplitude in X, Y and Z directions for two hours each									
Shock resistance	1,000 m/s ² acceleration (100 G approx.) in X, Y and Z directions for three times each									
Sensing range variation	Temperature characteristics	Over ambient temperature range − 10 to + 55 °C + 14 to + 131 °F: Within $\pm 15\%$ % of sensing range at + 20 °C + 68 °F								
	Voltage characteristics	Within ± 2 % for ± 10 % fluctuation of the supply voltage								
Material	Enclosure: PBT, Indicator part: Polyallylate				Enclosure: PET (Glass fiber reinforced) Indicator part: Polyallylate		Enclosure: PBT Indicator part: Polyallylate			
Cable (Note 3)	0.08 mm ² 3-core oil, heat and cold resistant cabtyre cable, 1 m 3.281 ft long		0.15 mm ² 3-core oil, heat and cold resistant cabtyre cable, 1 m 3.281 ft long		0.15 mm ² 3-core oil, heat and cold resistant cabtyre cable, 1 m 3.281 ft long		0.15 mm ² 3-core oil, heat and cold resistant cabtyre cable, 1 m 3.281 ft long		0.15 mm ² 3-core oil, heat and cold resistant cabtyre cable, 1 m 3.281 ft long	
Cable extension	Extension up to total 100 m 328.084 ft is possible with 0.3 mm ² , or more, cable.									
Weight	12 g approx.		20 g approx. 5 g approx.		20 g approx.			5 g approx.		20 g approx.
Accessories	MS-GXL8 (Sensor mounting bracket): 1 set		MS-GXL12-1 (Sensor mounting bracket): 1 pc. M3 pan head screw, plain washer, spring washer and nut: 1 set MS-R1 (Rubber washer): 1 pc.		MS-A15H (Aluminum sheet): 1 pc.		MS-GXL12-1 (Sensor mounting bracket): 1 pc. M3 pan head screw, plain washer, spring washer and nut: 1 set MS-R1 (Rubber washer): 1 pc.		—	

- Notes: 1) To mount the long sensing range GXL-15 type on a magnetic body, such as iron, the enclosed aluminum sheet or any other aluminum sheet having a minimum size of 30 × 30 × t 0.3 mm 1.181 × 1.181 × t 0.012 in, should be inserted between the sensor and the magnetic body. However, it is not necessary to use the aluminum sheet when mounting on a non-magnetic body, such as, aluminum or an insulator.
- 2) The maximum operation distance stands for the maximum distance for which the sensor can detect the standard sensing object. The stable sensing range stands for the sensing range for which the sensor can stably detect the standard sensing object even if there is an ambient temperature drift and/or supply voltage fluctuation.
- 3) The flexible cable type (model No. with suffix '-R') has a 0.15 mm² (GXL-8 type: 0.1 mm²) flexible, oil, heat and cold resistant cabtyre cable, 1 m 3.281 ft long.

I/O CIRCUIT AND WIRING DIAGRAMS

DC 2-wire type

GXL-8FU / GXL-8HU type

I/O circuit diagram

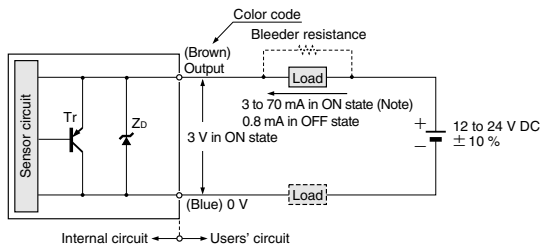

Wiring diagram

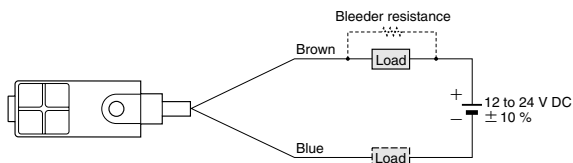

Symbols ... Z_d: Surge absorption zener diode
Tr: PNP output transistor

Note: The maximum load current varies depending on the ambient temperature.

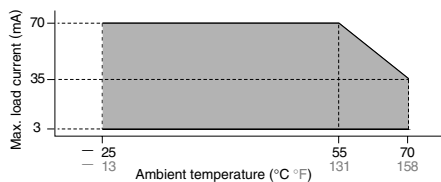

Conditions for the load

- 1) The load should not be actuated by the leakage current (0.8 mA) in the OFF state.
- 2) The load should be actuated by (supply voltage - 3 V) in the ON state.
- 3) The current in the ON state should be between 3 to 70 mA DC.
[In case the current is less than 3 mA, connect a bleeder resistance in parallel to the load so that a current of 3 mA, or more, flows.]

GXL-15FU / GXL-15HU / GXL-15FLU / GXL-15HLU type

I/O circuit diagram

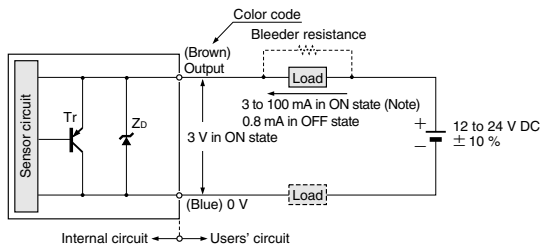

Wiring diagram

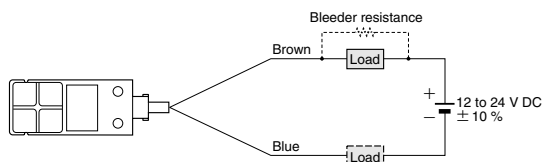

Symbols ... Z_d: Surge absorption zener diode
Tr: PNP output transistor

Note: The maximum load current varies depending on the ambient temperature.

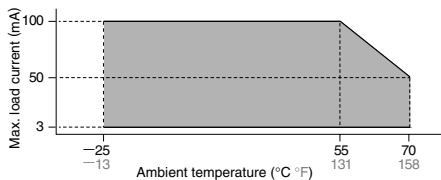

Conditions for the load

- 1) The load should not be actuated by the leakage current (0.8 mA) in the OFF state.
- 2) The load should be actuated by (supply voltage - 3 V) in the ON state.
- 3) The current in the ON state should be between 3 to 100 mA DC.
[In case the current is less than 3 mA, connect a bleeder resistance in parallel to the load so that a current of 3 mA, or more, flows.]

GXL

GL-6

GL-8/8U

Amplifier Built-in

GL-N12

GL-18H/18HL

GX-U/FU

GX-N

GX

Amplifier-separated
GA-10/GH

I/O CIRCUIT AND WIRING DIAGRAMS

NPN output type

I/O circuit diagram

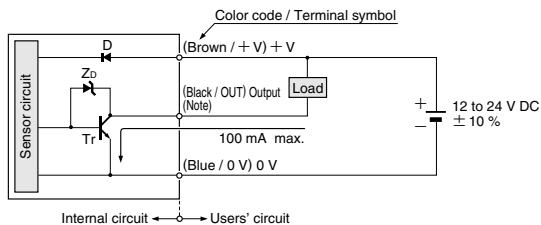

Wiring diagram

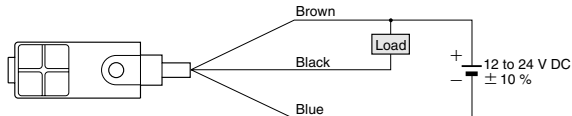

Note: The output does not incorporate a short-circuit protection circuit.
Do not connect it directly to a power supply or a capacitive load.

Symbols ... D : Reverse supply polarity protection diode
 Zd: Surge absorption zener diode
 Tr: NPN output transistor

PNP output type

I/O circuit diagram

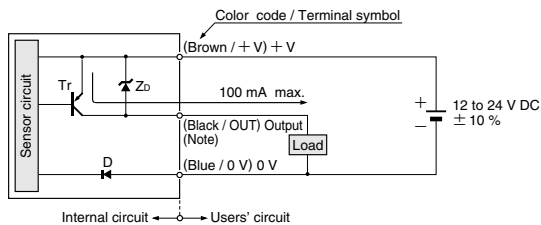

Wiring diagram

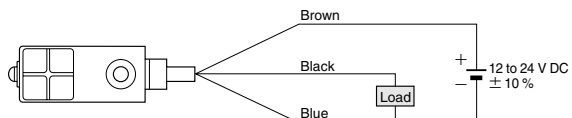

Note: The output does not incorporate a short-circuit protection circuit.
Do not connect it directly to a power supply or a capacitive load.

Symbols ... D : Reverse supply polarity protection diode
 Zd: Surge absorption zener diode
 Tr: PNP output transistor

SENSING CHARACTERISTICS (TYPICAL)

GXL-8 type

Sensing field (common)

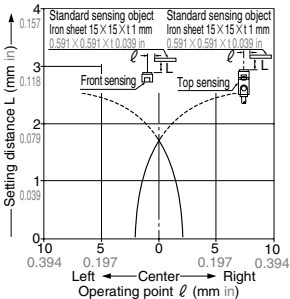

Correlation between sensing object size and sensing range (DC 2-wire type)

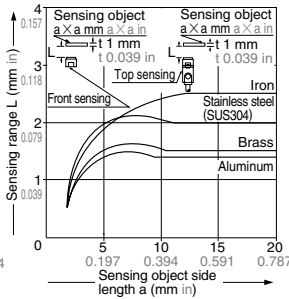

Correlation between sensing object size and sensing range (NPN output type)

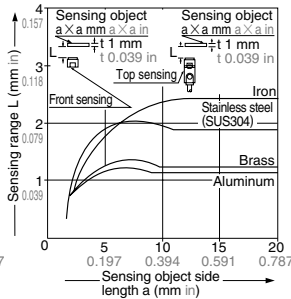

As the sensing object size becomes smaller than the standard size (iron sheet 15 × 15 × t 1 mm 0.591 × 0.591 × t 0.039 in), the sensing range shortens as shown in the left figures.

GXL-N12 type

Sensing field

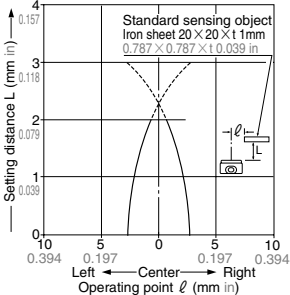

Correlation between sensing object size and sensing range

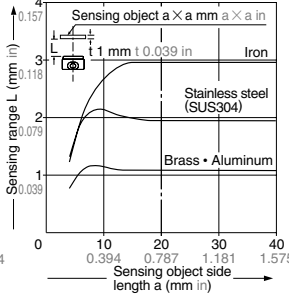

As the sensing object size becomes smaller than the standard size (iron sheet 20 × 20 × t 1 mm 0.787 × 0.787 × t 0.039 in), the sensing range shortens as shown in the left figure.

GXL-15 (Standard) type

Sensing field

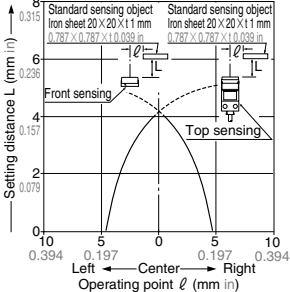

Correlation between sensing object size and sensing range

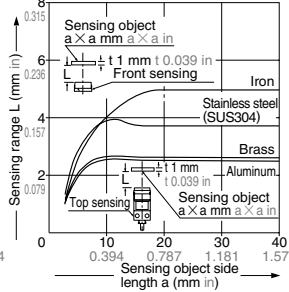

As the sensing object size becomes smaller than the standard size (iron sheet 20 × 20 × t 1 mm 0.787 × 0.787 × t 0.039 in), the sensing range shortens as shown in the left figure.

GXL-15 (Long sensing range) type

Sensing field

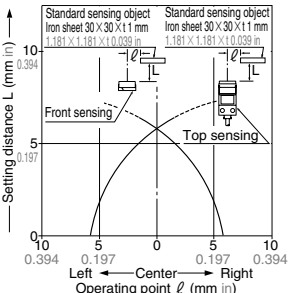

Correlation between sensing object size and sensing range

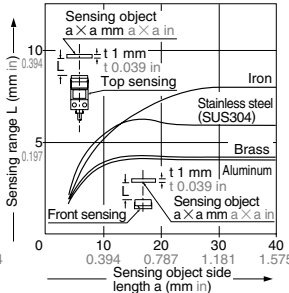

As the sensing object size becomes smaller than the standard size (iron sheet 30 × 30 × t 1 mm 1.181 × 1.181 × t 0.039 in), the sensing range shortens as shown in the left figure.

PRECAUTIONS FOR PROPER USE

Refer to p.1152~ for general precautions.

All models



This product is not a safety sensor. Its use is not intended or designed to protect life and prevent body injury or property damage from dangerous parts of machinery. It is a normal object detection sensor.

Mounting

GXL-8 (DC 2-wire) type

The tightening torque should be 0.5 N·m or less.

To mount the sensor with a nut, the thru-hole diameter should be $\phi 3.4$ mm $\phi 0.134$ in. With the attached mounting screw and nut, take care that the thickness of the mounting plate should be 2.3 mm 0.091 in or less.

If a screw other than the attached screw is used, make sure to use a M3 truss head screw.

(Do not use a flat head screw) or a pan head screw.

GXL-8 (NPN output) type

The tightening torque should be 0.5 N·m or less.

To mount the sensor with a nut, the thru-hole diameter should be $\phi 3$ mm $\phi 0.118$ in. With the attached mounting screw and nut, take care that the thickness of the mounting plate should be 2.3 mm 0.091 in or less.

If a screw other than the attached screw is used, make sure to use a M2.6 truss head screw.

Note: Do not use a M3 screw.

GXL-N12 type

<One point fixing>

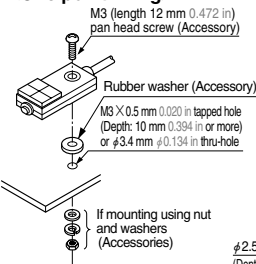

<Two point fixing>

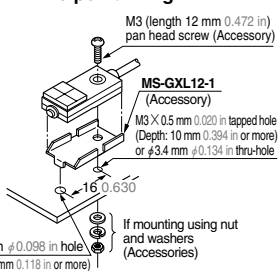

The tightening torque should be 0.49 N·m or less.

To mount the sensor with a nut, the thru-hole diameter should be $\phi 3.4$ mm $\phi 0.134$ in.

GXL-15 type

The tightening torque should be 1 N·m or less.

To mount the sensor with the optional sensor mounting bracket **MS-GXL15**, the thru-hole diameter should be $\phi 3.4$ mm $\phi 0.134$ in.

Screw, nut or washers are not supplied. Please arrange them separately.

To mount the long sensing range **GXL-15** type on a magnetic body, such as iron, the enclosed aluminum sheet, or any other aluminum sheet having a minimum size of 30 × 39.5 × t 0.3 mm 1.181 × 1.555 × t 0.012 in (**GXL-15HLU** □ / **GXL-15HL** □: 30 × 30 × t 0.3 mm 1.181 × 1.181 × t 0.012 in), should be inserted between the sensor and the magnetic body.

However, it is not necessary to use the aluminum sheet when mounting on a non-magnetic body, such as, aluminum or an insulator.

When mounting the inductive proximity sensor with the optional sensor mounting bracket **MS-GXL15-2**, if the bracket is mounted close to the sensing part, the bracket itself gets sensed and the operation becomes unstable. Make sure to mount such that the mounting holes of the sensor and those of the mounting bracket are in one horizontal straight line.

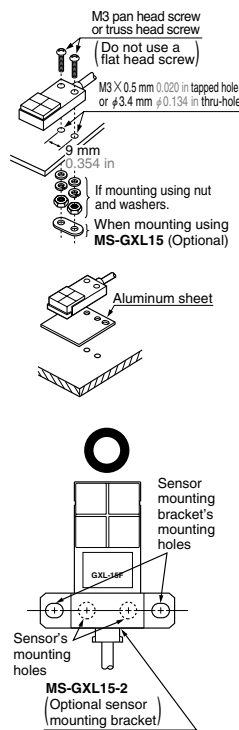

Influence of surrounding metal

When there is a metal near the sensor, keep the minimum separation distance specified below.

Front sensing type

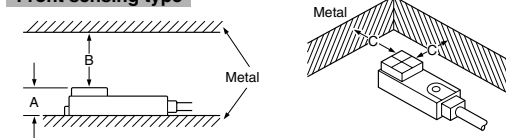

	GXL-8F type	GXL-N12F type	GXL-15FU / GXL-15F type	GXL-15FLU type
A	7 mm 0.276 in	7 mm 0.276 in	8 mm 0.315 in	8 mm 0.315 in (Note)
B	8 mm 0.315 in	20 mm 0.787 in	20 mm 0.787 in	30 mm 1.181 in
C	3 mm 0.118 in	10 mm 0.394 in	7 mm 0.276 in	10 mm 0.394 in

Note: The **GXL-15FLU** type should be mounted on an insulator or a non-magnetic body. To mount it on a magnetic body, such as iron, use the enclosed aluminum sheet.

Top sensing type

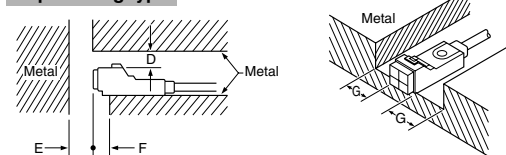

	GXL-8H type	GXL-15HU / GXL-15H type	GXL-15HLU / GXL-15HL type
D	4 mm 0.157 in	6 mm 0.236 in	12 mm 0.472 in
E	10 mm 0.394 in	20 mm 0.787 in	30 mm 1.181 in
F	3 mm 0.118 in	0 mm 0 in	10 mm 0.394 in (Note)
G	3 mm 0.118 in	3 mm 0.118 in	10 mm 0.394 in

Note: When **GXL-15HLU** / **GXL-15HL** type is mounted on an insulator or a non-magnetic body, or seated on the enclosed aluminum sheet, the distance 'F' can be zero.

PRECAUTIONS FOR PROPER USE

Refer to p.1152~ for general precautions.

All models

Mutual interference prevention

- When two or more sensors are installed in parallel or face to face, keep the minimum separation distance specified below to avoid mutual interference.

		H	J
GXL-8 type	Between 'I' type and non 'I' type	0 mm (Note 2) 0.591 in	15 mm 1.181 in
	Between two 'I' types or two non 'I' types	12 mm 0.472 in	30 mm 1.181 in
GXL-N12 type	Between 'I' type and non 'I' type	0 mm (Note 2) 0.591 in	15 mm 1.181 in
	Between two 'I' types or two non 'I' types	20 mm 0.787 in	40 mm 1.575 in
GXL-15F GXL-15FU GXL-15HU type	Between 'I' type and non 'I' type	0 mm (Note 2) 0.984 in	25 mm 2.362 in
	Between two 'I' types or two non 'I' types	30 mm 1.181 in	60 mm 2.362 in
GXL-15H type	Between 'I' type and non 'I' type	0 mm (Note 2) 0.984 in	25 mm 2.362 in
	Between two 'I' types or two non 'I' types	40 mm 1.575 in	60 mm 2.362 in
GXL-15FLU GXL-15HLU type	Between 'I' type and non 'I' type	0 mm (Note 2) 0.984 in	25 mm 3.543 in
	Between two 'I' types or two non 'I' types	75 mm 2.953 in	90 mm 3.543 in
GXL-15HL type	Between 'I' type and non 'I' type	0 mm (Note 2) 0.984 in	25 mm 3.740 in
	Between two 'I' types or two non 'I' types	80 mm 3.150 in	95 mm 3.740 in

Front sensing

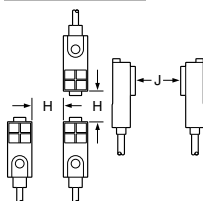

Top sensing

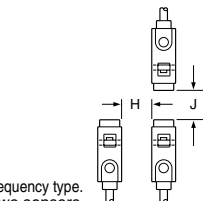

- Notes: 1) 'I' in the model No. specifies the different frequency type.
 2) Close mounting is possible for up to two sensors.
 When mounting three sensors or more, at an equal spacing, in a row, the minimum value of dimension H should be as given below.
GXL-8 type: 2 mm 0.079 in, **GXL-N12 type:** 4 mm 0.157 in
GXL-15 (Standard) type: 7.5 mm 0.295 in
(GXL-15H type: 12.5 mm 0.492 in)
GXL-15 (Long sensing range) type: 30 mm 1.181 in
(GXL-15HL type: 32.5 mm 1.280 in)

Sensing range

- The sensing range is specified for the standard sensing object. With a non-ferrous metal, the sensing range is obtained by multiplying with the correction coefficient specified below. Further, the sensing range also changes if the sensing object is plated.

Correction coefficient

Model No.	GXL-8FU GXL-8HU type	GXL-8F GXL-8H type	GXL-N12 type	GXL-15FU type	GXL-15HU GXL-15FLU GXL-15HLU type	GXL-15F GXL-15H type	GXL-15HL type
Metal							
Iron	1	1	1	1	1	1	1
Stainless steel (SUS304)	0.82 approx.	0.76 approx.	0.70 approx.	0.74 approx.	0.75 approx.	0.68 approx.	0.76 approx.
Brass	0.59 approx.	0.50 approx.	0.40 approx.	0.53 approx.	0.53 approx.	0.47 approx.	0.50 approx.
Aluminum	0.57 approx.	0.48 approx.	0.35 approx.	0.52 approx.	0.51 approx.	0.45 approx.	0.48 approx.

Others

- Do not use during the initial transient time [10 ms (DC 2-wire type: 50 ms)] after the power supply is switched on.
- The output does not incorporate a short-circuit protection circuit. Do not connect it directly to a power supply or a capacitive load (excluding the DC 2-wire type).

GXL-N12FT type CN-13

Soldering

- To solder the terminals of the sensor and connector CN-13, observe the following conditions.

- Soldering temperature: 260 °C 500 °F or less
 Soldering time : 5 sec. or less
 (CN-13: 10 sec. or less)
 Soldering position : 1.5 mm 0.059 in, or more, away from the sensor body.
-

DC 2-wire type

Wiring

- The sensor must be connected to a power supply via a load. If the sensor is connected to a power supply without a load, the short-circuit protection makes the sensor inoperable. (The output stays in the OFF state and the indicator does not light up.) In this case, rectify by connecting the power supply via a load. Now, the sensor becomes operable. Further, take care that if the power supply is connected with reverse polarity without a load, the sensor will get damaged.

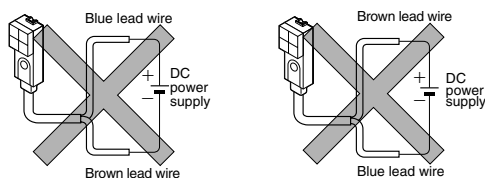

- For series connection (AND circuit) or parallel connection (OR circuit) of sensors, take care of the following.

Series connection (AND circuit) Parallel connection (OR circuit)

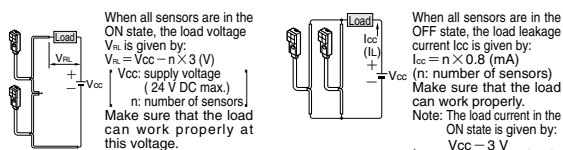

Note: The output is generated normally even if the indicator does not light up properly.

- The residual voltage of the sensor is 3 V. Before connecting a relay at the load, take care of its actuation voltage. (Some 12 V relays may not be usable.)

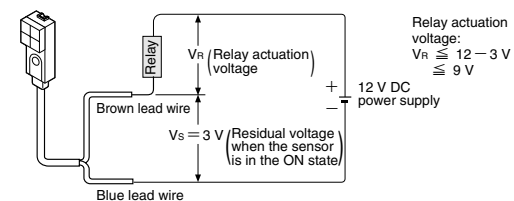

2-color indicator (Normally open type only)

- When the sensing object is in the stable sensing range, the LED lights up in green, and when the sensing object is in the unstable sensing range, the LED lights up in red. While the LED lights up in green, the sensing is performed stably without being affected by temperature drifts or voltage fluctuations.

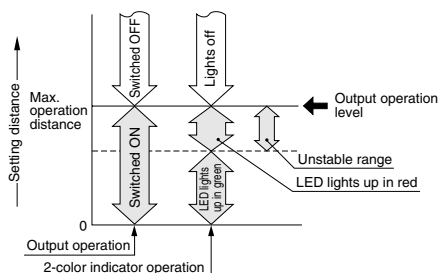

GXL

DIMENSIONS (Unit: mm in) The CAD data in the dimensions can be downloaded from the SUNX website: <http://www.sunx.co.jp/>

GXL-8FU type Sensor

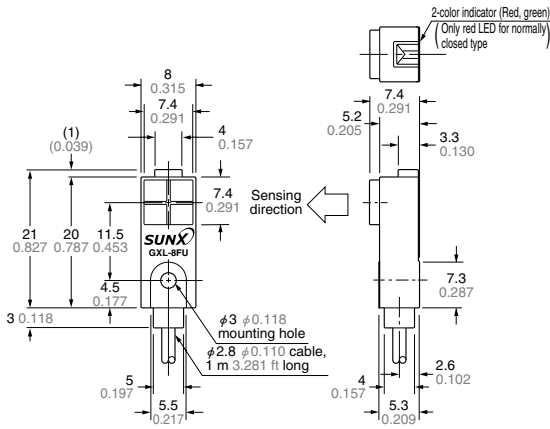

GXL-8HU type Sensor

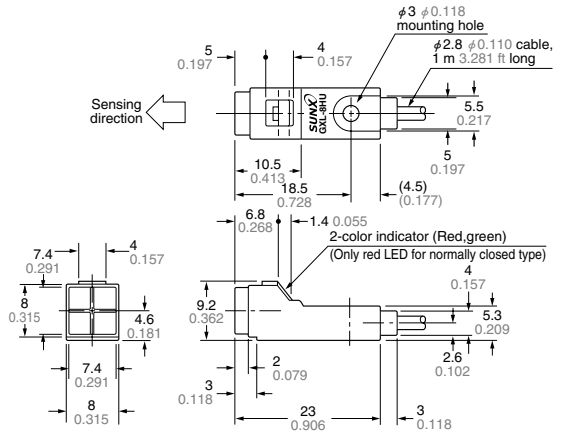

GXL-8F type Sensor

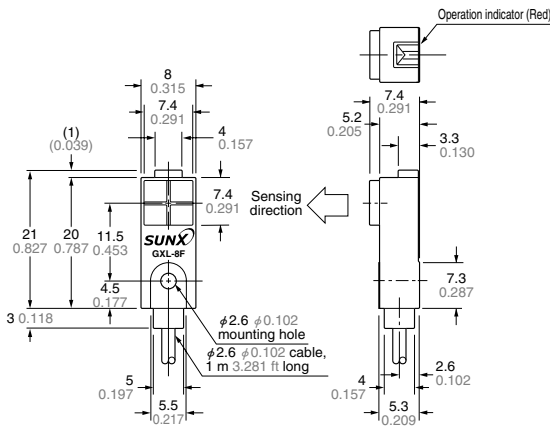

GXL-8H type Sensor

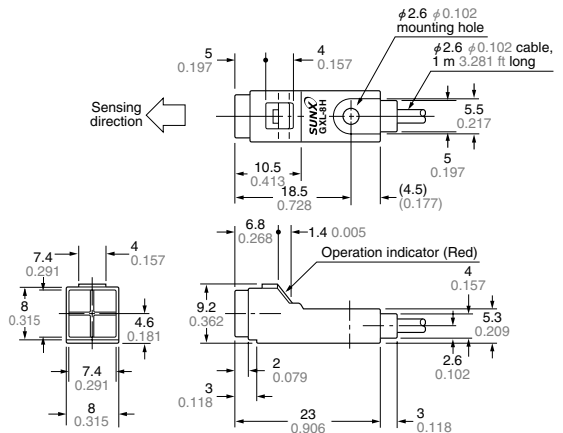

GXL-N12F type Sensor

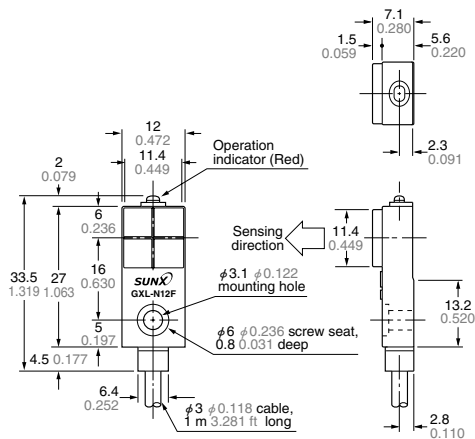

GXL-N12FT type Sensor

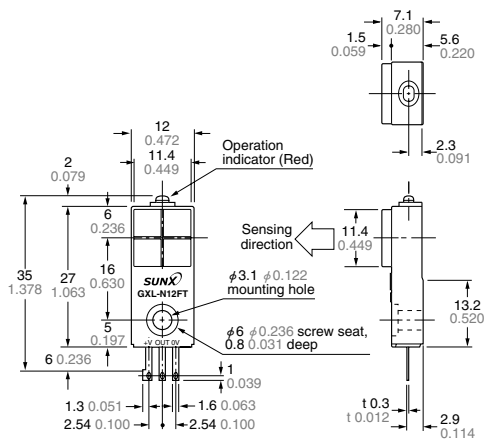

DIMENSIONS (Unit: mm in) The CAD data in the dimensions can be downloaded from the SUNX website: <http://www.sunx.co.jp/>

GXL-15F type Sensor

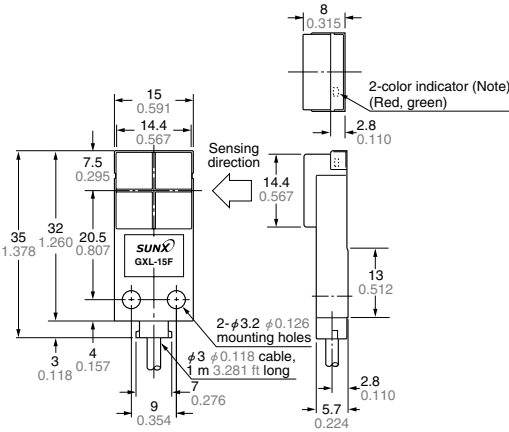

Note: Normally closed DC 2-wire type, NPN output type and PNP output type have an operation indicator (red) instead of the 2-color indicator.

GXL-15H type Sensor

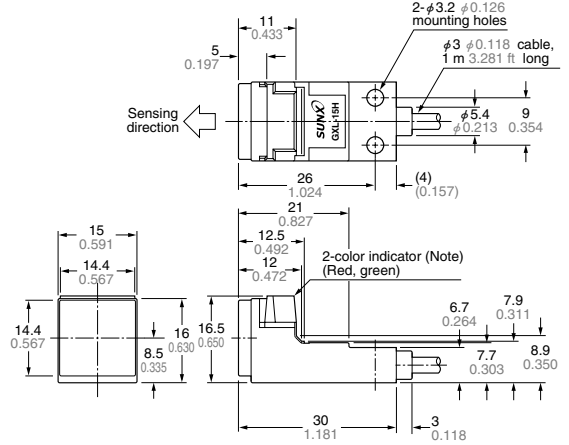

Note: Normally closed DC 2-wire type and NPN output type have an operation indicator (red) instead of the 2-color indicator.

MS-GXL8-4 Sensor mounting bracket for GXL-8FU / GXL-8HU type (Accessory)

Mounting hole dimensions

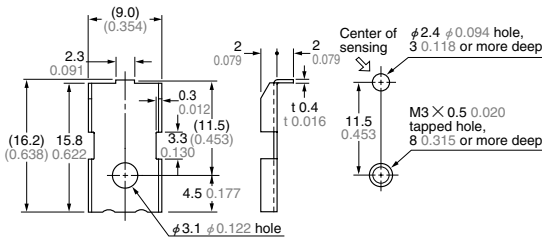

Material: Cold rolled carbon steel (SPCC)
(Nickel plated)

1 pc. each of M3 (length 12 mm 0.472 in) truss head screw, nut, spring washer and plain washer is attached.

MS-GXL8 Sensor mounting bracket for GXL-8F / GXL-8H type (Accessory)

Mounting hole dimensions

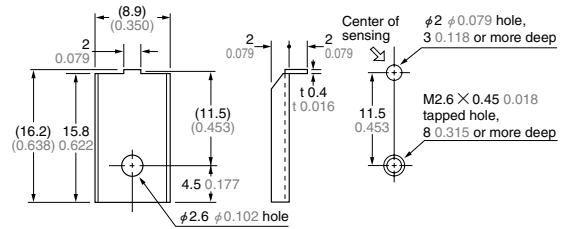

Material: Cold rolled carbon steel (SPCC)
(Nickel plated)

1 pc. each of M2.6 (length 12 mm 0.472 in) truss head screw, nut, spring washer and plain washer is attached.

MS-GXL12-1 Sensor mounting bracket for GXL-N12 type (Accessory)

Mounting hole dimensions

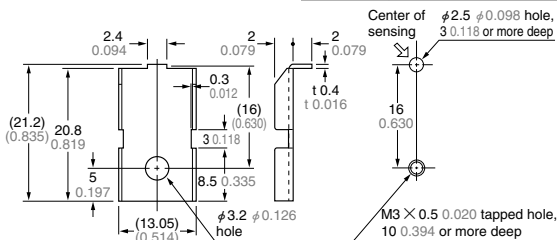

Material: Cold rolled carbon steel (SPCC)
(Nickel plated)

1 pc. each of M3 (length 12 mm 0.472 in) pan head screw, plain washer, spring washer and rubber washer (φ9.5 × t 0.5 mm φ0.374 × t 0.020 in) is attached.

MS-R1 Rubber washer for GXL-N12 type (Accessory)

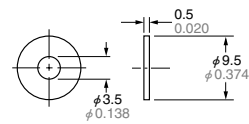

Material: NBR

GXL

DIMENSIONS (Unit: mm in) The CAD data in the dimensions can be downloaded from the SUNX website: <http://www.sunx.co.jp/>

MS-GXL8-3 Sensor mounting bracket for GXL-8F / GXL-8H type (Optional)

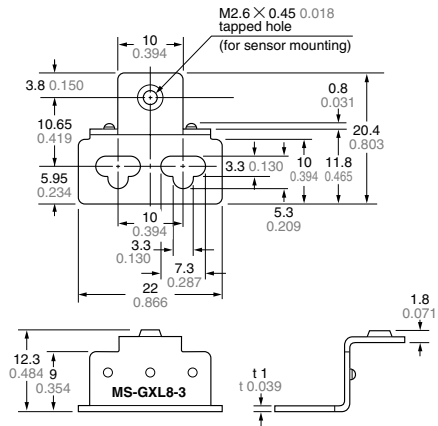

Material: Stainless steel (SUS304)
One M2.6 (length 8 mm 0.315 in) pan head screw and two M3 (length 8 mm 0.315 in) screws with washers are attached.

MS-GXL12-2 Sensor mounting bracket for GXL-N12 type (Optional)

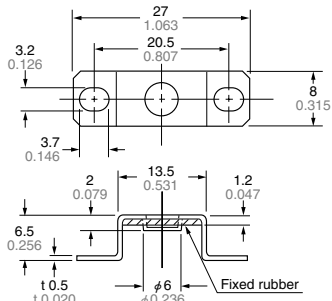

Material: Bracket ... Stainless steel (SUS304)
Fixed rubber ... FKM (Fluorine rubber)

MS-GXL15 Sensor mounting bracket for GXL-15 type (Optional)

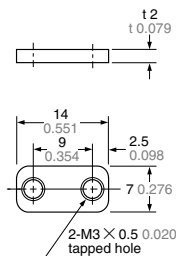

Material: Cold rolled carbon steel (SPCC)

MS-GXL15-2 Sensor mounting bracket for GXL-15F type (Optional)

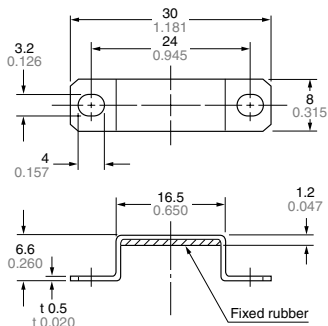

Material: Bracket ... Stainless steel (SUS304)
Fixed rubber ... FKM (Fluorine rubber)

CN-13 Connector for terminal type (Optional)

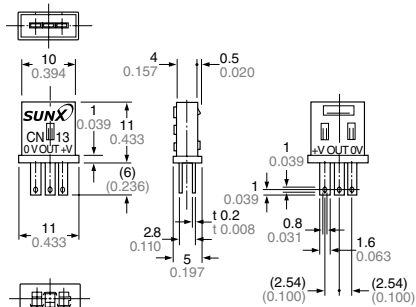

MS-A15F / MS-A15H Aluminum sheet (Accessory for GXL-15FLU, GXL-15HLU and GXL-15HL type)

